



AME SURGICAL INSTRUMENTS

Diagnostic/ Preparation Instruments



AME GLOBAL FZE
www.ameglobalfze.com

- **HAMMERS**
- **STETHOSCOPE**
- **CATHER FORCEPS**
- **LARYNGOSCOPES**
- **DISSECTING KITS**
- **CALIPERS**
- **SUCTION TUBES**
- **TROCARS**

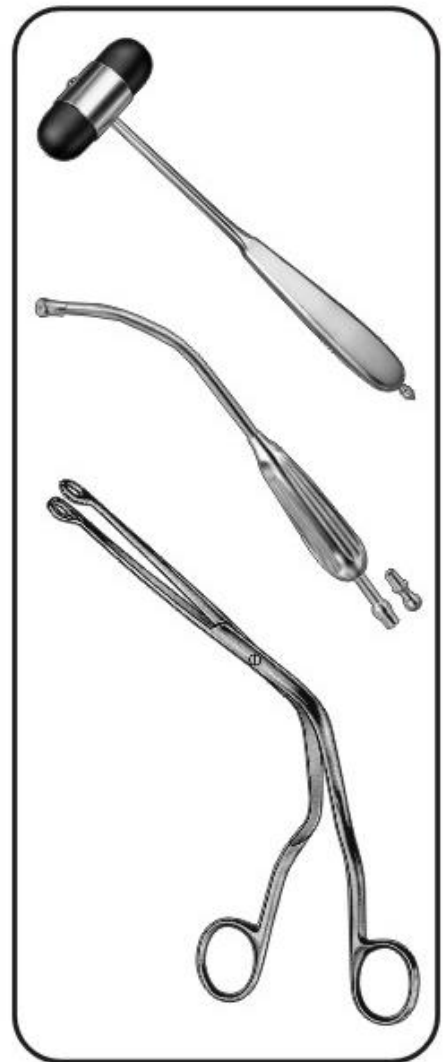
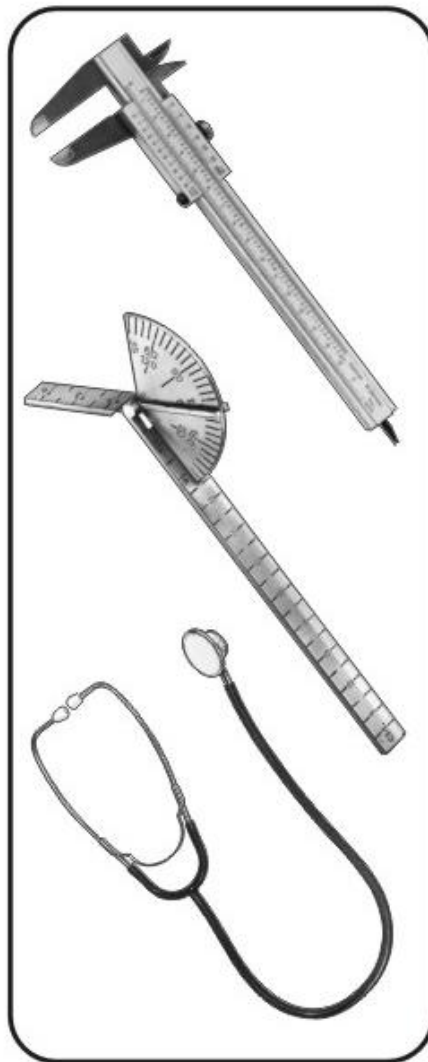



NEURO-DUOFLEX
11-001-220
22 cm, 8 3/4"



DEJERINE
11-002-200
20 cm, 8"



DEJERINE
11-003-200
20 cm, 8"



TROEMNER
11-004-245 145 g
11-005-245 175 g
11-006-245 235 g
24.5 cm, 9 3/4"
spare rubber



TROEMNER-SIMPLEX
11-007-210
21 cm, 8 1/4"



BUCK
11-008-185
18.5 cm, 7 1/4"



**BUCK
HAMMER**
11-009-180
18 cm, 7"



TAYLOR
11-010-180 18 cm, 7"
11-011-200 20 cm, 8"



TAYLOR
11-012-180
18 cm, 7"



BABINSKY
11-013-220
22 cm, 8 3/4"



BABINSKY
11-014-220
22 cm, 8 3/4"



RABINER
11-015-255
25.5 cm, 10"
with needle & brush



BERLINER
11-016-200
20.0 cm, 8"



TRAUBE
11-017-160
16 cm, 6 1/4"



WARTENBERG
11-018-190
19 cm, 7 1/2"



DUPLEX
11-019-000
super lightweight



DUPLEX-BABY
11-020-000
super lightweight



ANAESTOPHON
11-021-000
super lightweight



PINARD WOODEN
11-022-180
18 cm, 7"



PINARD ALUMINIUM
11-023-150
15 cm, 6"



WEBER
11-024-090
9.0 cm, 3 1/2"
Aesthesiometer

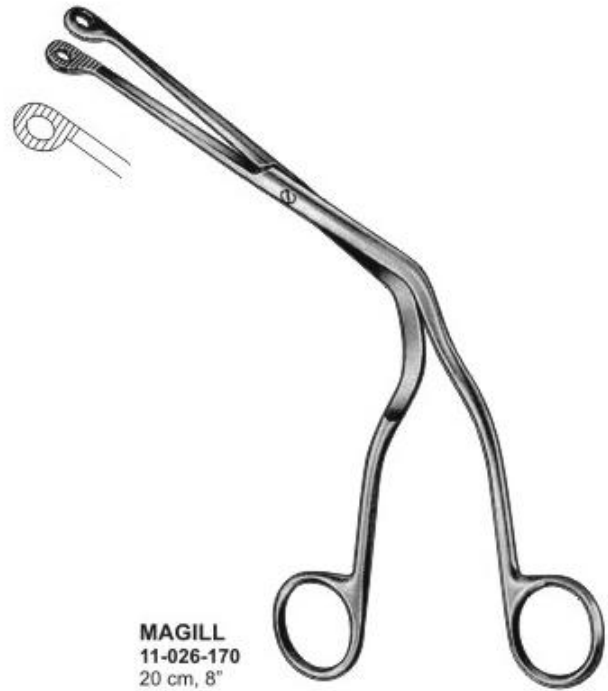



Diagnostic/Preparation Instruments



OTOSCOPE SET (color available)
11-054-000



MINI OTOSCOPE SET
11-056-000



OTOSCOPE SET
11-055-000

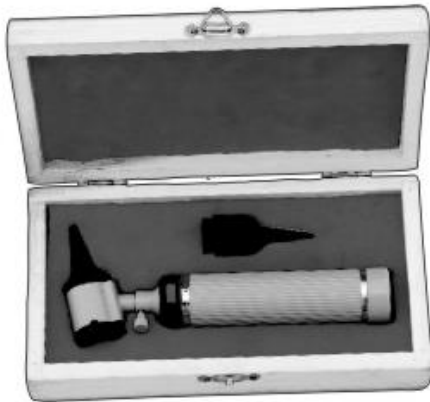

OTOSCOPE SET
11-059-000



DIAGNOSTIC SET
11-033-000



**OTOSCOPE /
OPHTHALMOSCOPE SET**
11-057-000



DIAGNOSTIC SET
11-058-000



GUEDEL-NEGUS
11-034-00 Battery handle only
 Fiber Optic
 Laryngoscope set
 with 4 blades
 (fig. 01 to 04) in
 wooden/ rexin box.



MCINTOSH
11-039-00
 Fiber Optic Laryngoscope set
 with 4 blades
 (fig. 01 to 04) in wooden/ rexin box.



Fig. 01
11-045-01

Fig. 02
11-046-02

Fig. 03
11-047-03

Fig. 04
11-048-04



BATTERY HANDLE
11-049-250
 without battery
 Use with battery - Size C
 (11-045-01 – 11-048-04
 11-050-01 – 11-053-04)

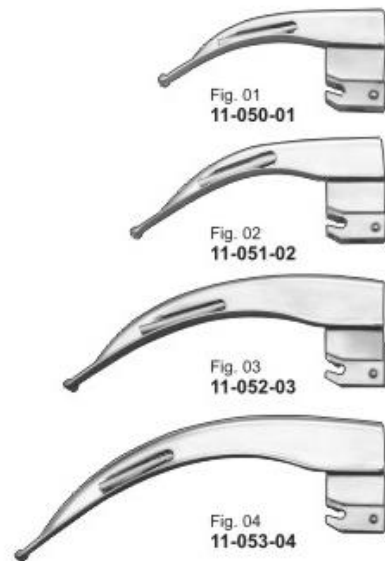

Fig. 01
11-050-01

Fig. 02
11-051-02

Fig. 03
11-052-03

Fig. 04
11-053-04



GUEDEL-NEGUS / MILLER

11-061-000
with three blade
blades No. 1 to 3
complete, in case.

11-062-000
With four blade
blades No. 1 to 4
complete, in case.



FOREGGER

11-074-000
with three Four Blades
complete, in case.



11-063-001
for children
working length
70 mm



11-064-002
for adolescents
working length
90 mm



11-065-003
for women
working length
110 mm



11-066-004
for men
working length
175 mm



11-075-001
for children
working length
70 mm



11-076-002
for adolescents
working length
90 mm



11-077-003
for women
working length
110 mm



11-078-004
for men
working length
175 mm



CONVENTIONAL SET



CONVENTIONAL SET
11-079-000
MAC + MILLER COMBO
Double Set of 10 Pcs.
4 Miller Blades
4 Mac Blades
1 Handle Small
1 Handle Medium

FIBEROPTIC SET



MAC + MILLER COMBO SET
11-080-000
Double Set of 10 Pcs.
4 Miller Blades
4 Mac Blades
1 Handle Small
1 Handle Medium



FIBEROPTIC SETS



MAC SET
11-081-000
Set of 5 pcs.



MILLER SET
11-082-000
Set of 5 pcs.

DISPOSABLE LARYNGOSCOPE SETS



MAC DISPOSABLE SET
11-083-000
Set of 4 Blade + 1 Handle



MILLER DISPOSABLE SET
11-084-000
Set of 4 Blade + 1 Handle

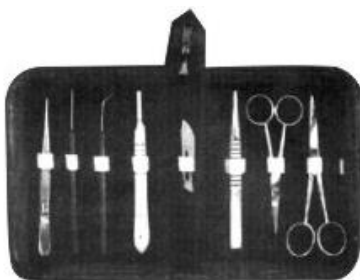

- 11-085-001**
Set of 9 Pcs.
- Dissecting Forceps 11.5cm Sharp Point.
 - Teasing needle Sharp STR.
 - Teasing Needle Sharp Angular.
 - B.P Handle No.4.
 - Blade No. 22.
 - Thumb Forcep T.O.E 13cm.
 - Dissecting Scissor STR 11.5cm.
 - Dissecting Scissor STR 13cm.
 - Zipper Case Inside Red Velvet.

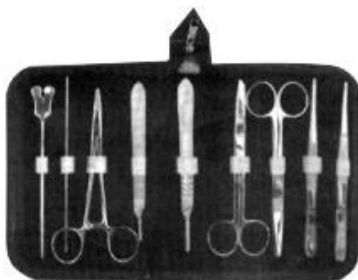

- 11-086-002**
Set of 10 Pcs.
- Grooved Director with Tongue Tie 14cm.
 - Probe Double 14cm.
 - Mayo Hegar Needle Holder 14cm.
 - B.P Handle No.3
 - B.P Handle No.4
 - Dressing Scissor 14cm S/B STR.
 - Dressing Scissor 14cm S/B CVD.
 - Dressing Forcep 1x2 teeth 14cm.
 - Dressing Forcep Serrated 14cm.
 - Zipper Case Inside Red Velvet.



- 11-087-003**
Set of 10 Pcs.
- Probe Double 13cm.
 - 2PCS. Scalpel S.S.
 - Grooved Director With Tongue Tie 14cm
 - Mayo Hegar Needle Holder 14cm.
 - Dissecting Forceps 14cm 1x2 Teeth.
 - Dressing Forceps 14cm Serrated.
 - Dressing Scissor 14cm S/B STR.
 - Dressing Scissor 14cm S/B CVD.
 - Zipper Case Inside Red Velvet.



- 11-088-004**
Set of 10 Pcs.
- Blow Pipe.
 - 3PCS Scalpel.
 - Dissecting Forceps 14cm.
 - Grooved Director With Tongue Tie 14cm
 - Triple Chain Hook.
 - Dressing Scissor Probe Pointed 14cm.
 - Probe Double 14 cm.
 - Zipper Case Inside Red Velvet.



DISSECTING SET
11-089-005 Containing 9 Instruments



11-090-006
Set of 6 pcs.

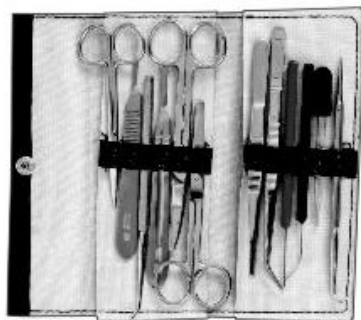

11-091-007
Set of 12 pcs.



DISSECTING KET
11-092-008
Set of 2 pcs.



GRADUATED TAPE MEASURER

11-093-001
2 m long (1.5 m) graduated in inch & cm markings



11-094-150
15 cm, 6"
cm & mm markings

GRADUATED METAL RULER



JAMESON
11-095-001



TOWNLEY
11-096-115
11.5 cm, 4 1/4"



MÖLTGEN
11-097-001



CARROLL
11-098-145
14.5 cm, 5 3/4"



CALIPER
11-099-150
15.0 cm, 6"

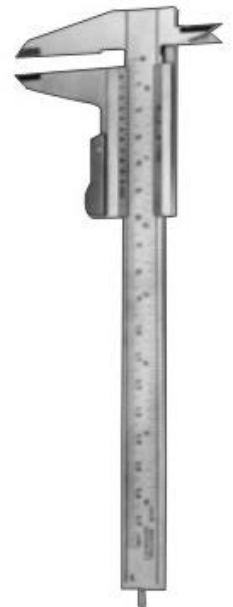

VERNIER
11-100-120
12 cm, 5"



CASTROVIEJO-EPKER
11-101-090
 9 cm, 3 1/2"
 Measuring range
 40 mm



CASTROVIEJO-EPKER
11-102-180
 18 cm, 7"
 Measuring range
 40 mm, straight



CASTROVIEJO-EPKER
11-103-180
 18 cm, 7"
 Measuring range
 40 mm, curved



CASTROVIEJO
11-104-080
 8 cm, 3"
 Measuring range
 15 mm



CASTROVIEJO
11-105-080
 8 cm, 3"
 Measuring range
 20 mm



CASTROVIEJO
11-106-080
 8 cm, 3"
 Measuring range
 20 mm

Ø 1.5 mm



COUPLAND
11-107-001

Ø 2.0 mm



BYRD
11-108-01 1.5 mm
11-109-02 2.5 mm
11-110-03 3.5 mm

Ø 8.0 mm



COOLEY
11-111-330
33.0 cm, 13"



MILLIN'S SUCTION TUBE
11-112-001
chromium-plated,
with sliding "on & off"
action.

Ø 8.0 mm



COOLEY
11-113-350
35 cm, 13 3/4"

Ø 6.0 mm



COOLEY
11-114-300
30.0 cm, 12"

Ø 10.0 mm



COOLEY
11-115-310
31.0 cm, 12 1/4"



11-116-170
17 cm, 6 1/4"
For aspirating fluid from the excretory ducts of large glands and for keeping the operating area clear



11-117-150
15 cm, 6"
For aspirating fluid from the excretory ducts of large glands and for keeping the operating area clear



11-118-190
19 cm, 8 1/4"
For aspirating fluid from the excretory ducts of large glands and for keeping the operating area clear



BIEMER
11-119-004 Ø 4 mm
11-120-006 Ø 6 mm
11-121-008 Ø 8 mm
11-122-010 Ø 10 mm
11-123-012 Ø 12 mm
11-124-014 Ø 14 mm
Curettes for aspiration lipectomy, graduated, slightly curved



BIEMER
11-125-004 Ø 4 mm
11-126-006 Ø 6 mm
Curettes for aspiration lipectomy, with three apertures, slightly curved malleable



BIEMER
11-127-008 Ø 8 mm
11-128-010 Ø 10 mm
11-129-012 Ø 12 mm
Curettes for aspiration lipectomy, with three apertures, slightly curved malleable



11-130-230
23 cm, 9"
double curved
for general
surgery



11-131-190
19 cm, 8 1/4"
double curved
for general
surgery



11-132-220
22 cm, 8 3/4"
double curved
for general
surgery



TROCAR
11-133-170
17 cm, 6 1/4"
For puncturing



HOLLOW NEEDLE
11-134-150
15 cm, 6"
sharp

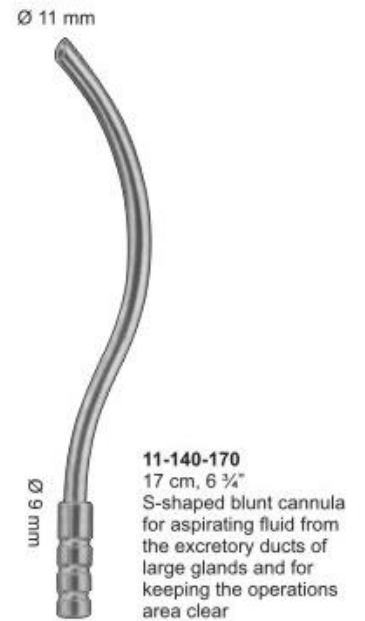
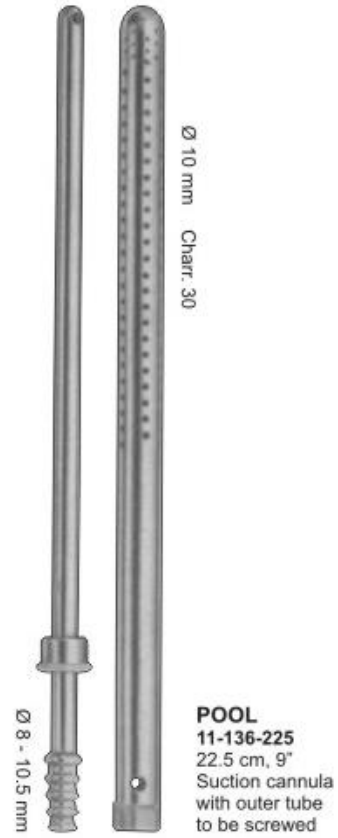

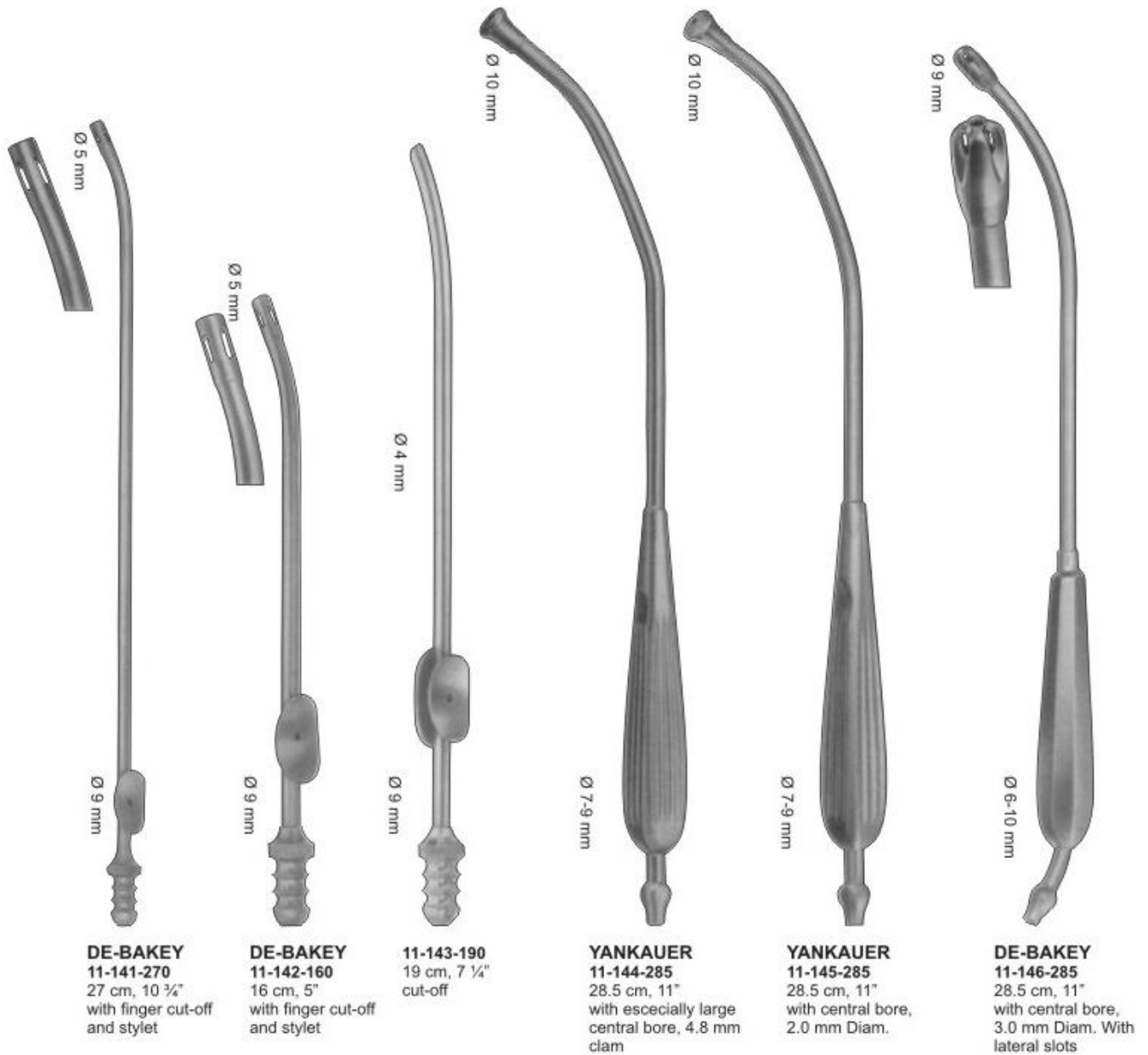



ADSON
11-147-150 4 mm Ø
 15 cm, 6"



ADSON
11-148-150 4 mm Ø, 15 cm, 6"
11-149-200 4 mm Ø, 20 cm, 8"
11-150-200 5 mm Ø, 20 cm, 8"



PLESTER
11-151-01 1.5 mm Ø
11-152-02 2.0 mm Ø
11-153-03 2.5 mm Ø
11-154-04 3.0 mm Ø



FRAZIER-FERGUSON
11-155-114 6 Fr.
11-156-114 7 Fr.
11-157-114 9 Fr.
11-158-114 10 Fr.
11-159-114 11 Fr.
 11.4 cm, 4 1/2"



FRAZIER
11-160-190 6 Fr.
11-161-190 7 Fr.
11-162-190 9 Fr.
11-163-190 11 Fr.
 19 cm, 7 1/2"



FRAZIER 30°
11-164-180 6 Fr.
11-165-180 7 Fr.
11-166-180 8 Fr.
11-167-180 9 Fr.
11-168-180 10 Fr.
11-169-180 11 Fr.
11-170-180 12 Fr.
11-171-180 15 Fr.
 18 cm, 7"

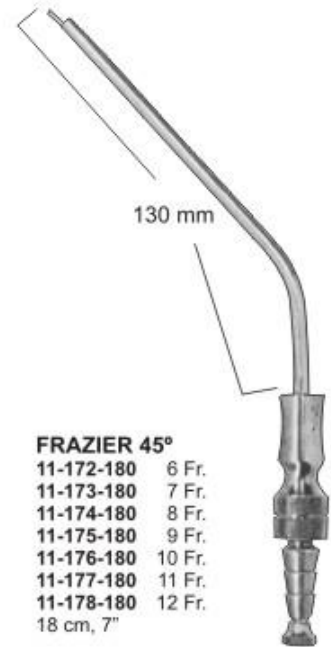

FRAZIER 45°
11-172-180 6 Fr.
11-173-180 7 Fr.
11-174-180 8 Fr.
11-175-180 9 Fr.
11-176-180 10 Fr.
11-177-180 11 Fr.
11-178-180 12 Fr.
 18 cm, 7"



11-179-175 Ø 4.5 mm
11-180-175 Ø 5.5 mm
17.5 cm, 7"
Nasal suction tubes



GORNEY
11-181-180
18 cm, 7"
suction dissector



11-182-200 4 mm wide
11-183-200 5 mm wide
20 cm, 8"
suction raspatories, sharp, bayonet-shaped, with stylet



LOPEZ-REINKE
11-184-235
23.5 cm, 9"
tonsil dissector with suction device



PLESTER
19.5 cm, 8"
with finger cut-off and stylet, thumb piece parallel to curved, with Luer hub



FERGUSSON
18 cm, 7"
with finger cut-off and stylet, thumb piece 90° to curved, with Luer hub



FERGUSSON
11-194-180 Ø 4.0 mm
18 cm, 7"
insulated, with finger cut-off and stylet, thumb piece 90° to curved, with Luer hub



FRAZIER
11-195-180 Ø 3.0 mm
11-196-180 Ø 5.0 mm
18 cm, 7"
insulated, with finger cut-off and stylet, thumb piece 90° to curved, with Luer hub



11-197-180
18 cm, 7"
Ø 5.0 mm diam., Tip 6.5 mm wide nasal section tube, with Luer hub

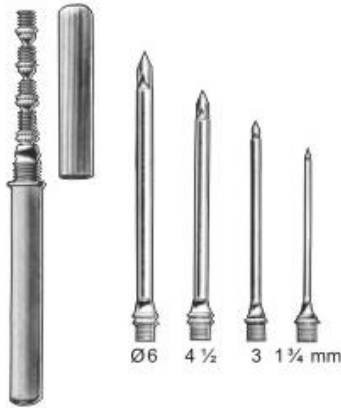

UNIVERSAL
11-198-01
Set of 3 Pieces
11-199-02
Set of 4 Pieces



LUER
11-200-01
Luer lock adapter



UNIVERSAL
11-201-140
14 cm, 5 1/2"



Complete
1.8 mm Ø

LICHTWITZ
11-202-185
18.5 cm, 7 1/4"
antrum trocar



FRAZIER

Fig.	Item	Description	W.L	Tip
A	11-203-180	(18 cm, 7") Angled-75°	4.75"	10 French
B	11-204-180	(18 cm, 7") Angled-75°	4.75"	12 French



YANKAUER
11-205-270
27 cm, 10 3/4"

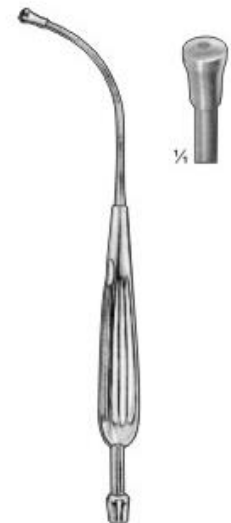

ANDREWS-PYNCHON
11-206-235
23.5 cm, 9 1/4"



STANDARD
18.5 cm, 7 1/4"
With stopcock and drain
11-207-185 3 mm x 80 mm
11-208-185 4 mm x 80 mm
11-209-185 5 mm x 80 mm
11-210-185 6 mm x 80 mm



STANDARD
18.5 cm, 7 1/4"
With Stopcock
11-211-185 3 mm x 80 mm
11-212-185 4 mm x 80 mm
11-213-185 5 mm x 80 mm
11-214-185 6 mm x 80 mm



NELSON
Abdominal Trocars
11-215-170 3.0 mm x 80 mm 17.0 cm, 6 3/4"
11-216-170 4.0 mm x 80 mm 17.0 cm, 6 3/4"
11-217-170 5.0 mm x 80 mm 17.0 cm, 6 3/4"
11-218-170 6.0 mm x 80 mm 17.0 cm, 6 3/4"
11-219-210 7.5 mm x 110 mm 21.0 cm, 8 1/4"
11-220-210 9.5 mm x 110 mm 21.0 cm, 8 1/4"
11-221-210 11.0 mm x 110 mm 21.0 cm, 8 1/4"

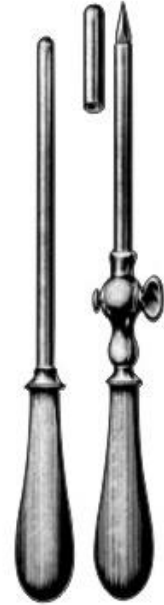

BUELAU
11-222-240 8 mm
24.0 cm, 9 1/2"



FLEURANT
11-223-230
23 cm, 9"
5 mm Ø



FLEURANT
11-224-230
23 cm, 9"
5 mm Ø



FLEURANT
11-225-230
23 cm, 9"
5 mm Ø



DOUGLAS
11-226-03
3 mm Ø



11-227-110
11 cm, 4 1/2"



OCHSNER
Gall Bladder Trocars
11-228-140 4.0 mm x 100 mm
11-229-140 5.5 mm x 100 mm
11-230-140 6.5 mm x 100 mm
14.0 cm, 5 1/2"



LICHTWITZ
Antrum Trocars
11-231-001
1.8 mm



PIERCE
11-232-004
4.0 mm



KRAUSE
11-233-005
5.5 mm



KRAUSE
11-234-005
5.5 mm



COAKLEY
11-235-002
2.25 mm



LANDAU
11-236-002
2.0 mm



VOGEL
Dilatation Forceps
11-237-265
26.5 cm, 10 1/2"



DUKE
11-238-110
11 cm, 4 1/4"
5.5 mm



BIRCH
11-239-180
18 cm, 7"
4.5 mm



NELSON
21 cm, 8 1/4"



1/4
11-240-210
21 cm, 8 1/4"



1/4
11-242-210
21 cm, 8 1/4"



1/4
11-241-210
21 cm, 8 1/4"



1/4
11-243-210
21 cm, 8 1/4"



FINSTERER
11-273-320
32 cm, 12 3/4"

Ø 9-13 mm

Ø 15 mm

Ø 2 mm

Ø 4.5 mm

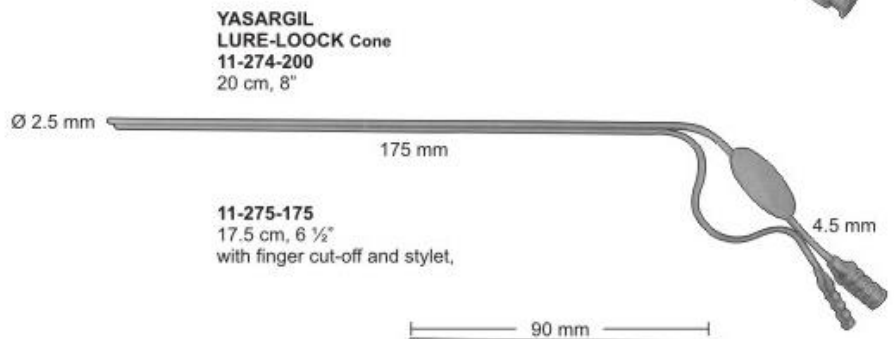

YASARGIL
LURE-LOCK Cone
11-274-200
20 cm, 8"

Ø 2.5 mm

175 mm

11-275-175
17.5 cm, 6 1/2"
with finger cut-off and stylet,

4.5 mm

90 mm

HOUSE
11-276-001

	Suction tube diam.	irrigationtube diam.
11-277-001	0.9 mm	0.7 mm
11-278-002	1.2 mm	0.9 mm
11-279-003	1.5 mm	1.2 mm

with finger cut-off and stylet,
with lure hub

4 mm

Ø 9-6 mm



11-280-001 3.5 mm
with LURE-LOCK cone

250 mm

Ø 9 mm

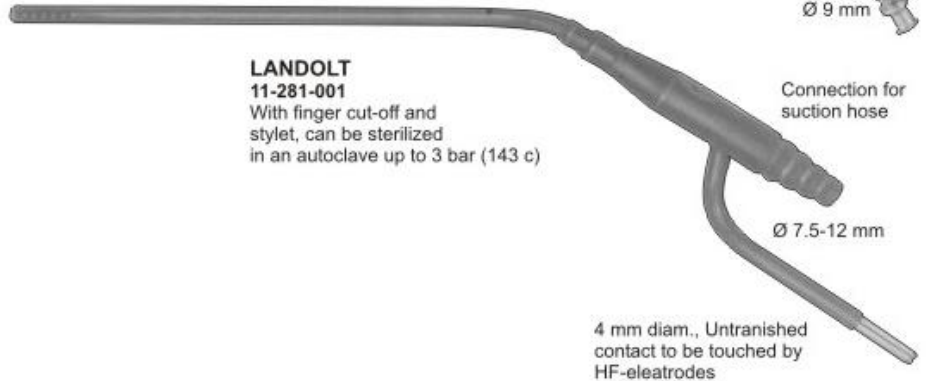

LANDOLT
11-281-001
With finger cut-off and stylet, can be sterilized in an autoclave up to 3 bar (143 c)

Connection for suction hose

Ø 7.5-12 mm

4 mm diam., Untrashed contact to be touched by HF-electrodes

Ø 1.75 mm

WULLSTEIN
11-244-160
 16 cm, 5 ¼"
 Suction tube, conical, silver, oliver
 with LUER hub

WULLSTEIN
11-245-160 Ø 1.5 mm
11-246-160 Ø 2.0 mm
 16 cm, 5 ¼"
 Suction tube, cylindrical, silver, with
 stylet with LUER hub

Usable length

YASARGIL		usable length		diam.		YASARGIL		usable length		diam.	
11-247-130	13 cm, 5"			1.5 mm		11-255-130	13 cm, 5"			2.5 mm	
11-248-150	15 cm, 6"			1.5 mm		11-256-150	15 cm, 6"			2.5 mm	
11-249-180	18 cm, 7"			1.5 mm		11-257-180	18 cm, 7"			2.5 mm	
11-250-220	22 cm, 8 ¾"			1.5 mm		11-258-220	22 cm, 8 ¾"			2.5 mm	
11-251-130	13 cm, 5"			2.0 mm		11-259-130	13 cm, 5"			3.5 mm	
11-252-150	15 cm, 6"			2.0 mm		11-260-150	15 cm, 6"			3.5 mm	
11-253-180	18 cm, 7"			2.0 mm		11-261-180	18 cm, 7"			3.5 mm	
11-254-220	22 cm, 8 ¾"			2.0 mm		11-262-220	22 cm, 8 ¾"			3.5 mm	
						11-263-180	18 cm, 7"			4.5 mm	

Ø 6.5-9 mm
with LUER hub

LANDOLT
11-264-150
 15 cm, 6"
 diam Ø 3mm

11-265-008 08 mm / curved
11-266-011 11 mm / curved
11-267-015 15 mm / curved

Ø 3.5 mm

Ø 2.0 mm

11-268-350 35 cm, 14"
11-269-500 50 cm, 20"
 with rubber tip,
 with LUER hub

Ø 9 mm

11-270-250 Ø 2.0 mm
11-271-250 Ø 2.5 mm
11-272-250 Ø 3.0 mm
 25 cm, 10"
 with finger cut-off
 thumb piece 90 to
 curved, with luer hub

Ø 6-9 mm